

Flexible stainless steel insulated piping SolarFlex

NA3540-15

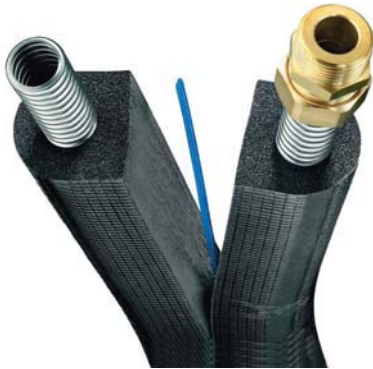

Function

SolarFlex is a system solution with pre-insulated flow and return pipes for solar hot water heating systems used to connect the solar collector with the storage tank in an easy, quick and professional way. It optimizes thermal efficiency of the entire system. The pre-insulation solution of two flexible stainless steel pipes inside two EPDM closed cell insulation and the integrated sensor cable, saves time and reduces cost of installation. SolarFlex is packaged in a 50-foot continuous coil with a complete range of accessories to ensure a smooth and secure installation.

General

- Easy to separate, without damaging the tubes.
- External copolymer foil protects against UV radiation and mechanical strain.
- Identification mark for flow and return.
- Meets highest requirements for modern solar heating systems.
- Pre-insulated feed and return pipes can be joined easily without special tools.

Product range

- Code NA3540-15 SolarFlex 50 foot coil with four 1" union nuts, four segment rings, four flat-sealing washers and two 1" double nipples
 Code NA637304 SolarFlex pipe hangers includes four hanger and mounting hardware
 Code NA1210-3 SolarFlex connection kit includes four 1" union nuts, four segment rings and four flat-sealing washers

Technical specifications

Materials:

- pipe: two corrugated stainless steel 316L
- insulation: two closed cell elastomer UV resistance EPDM
- outer cover: UV resistant polyolefin copolymer foil

Insulation thickness: 5/8 inch (16mm)

Thermal conductivity at 105°F (40°C): R-3.6 (.04W/mK)

- Max. working pressure: 150 psi (10 bar)
- Max. fluid temperature: 350°F (175°C)
- Min. surface temperature: -60°F (-50°C)
- Length per coil: 50 feet (15m)
- Fluid capacity per foot: 0.0346 gallons (0.13 liters)
- Min. bending radius: 5 inch (130mm)

Dimensions

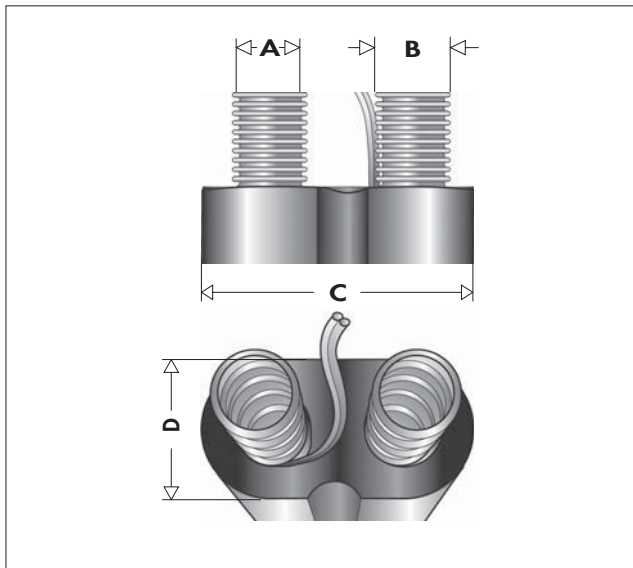

Code	A	B	C	D	Weight (lb/ft)
NA3540-15	3/4"	15/16"	4"	2 1/8"	0.5

Hydraulic characteristics

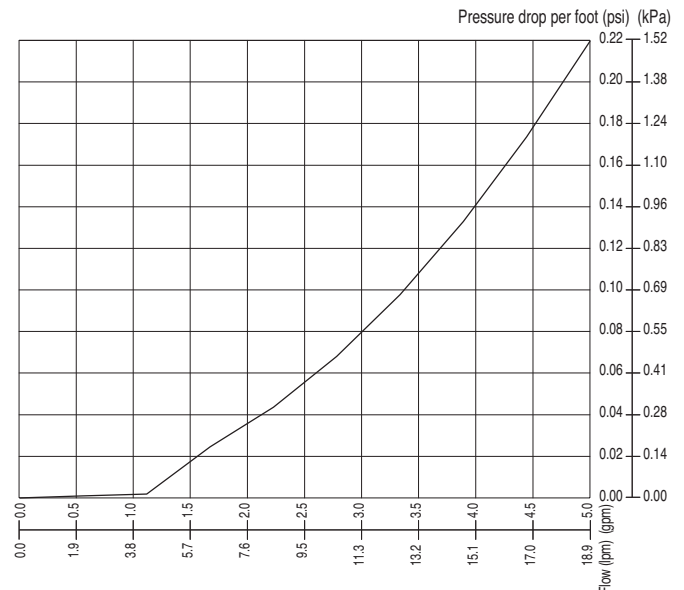

Example: pressure drop at a flow of 3.0 gpm = 0.08 psi x 50 feet of pipe = 4 psi

General

SolarFlex pipe is a flexible, quick installation system to connect solar collectors to the pump station and to the storage tank. The pipe system is easy to install, enabling pipes to be run without using a torch in confined spaces or on the roof. Two closed cell elastomeric foam extrusions of high temperature resistant EPDM are protected against damages by a common outer cover. Flow and return pipes can be easily separated without damaging the insulation.

SolarFlex is the way to reduce installation time while ensuring a leak-free installation. SolarFlex's union nut assembly method does not require special tools or time.

Construction details

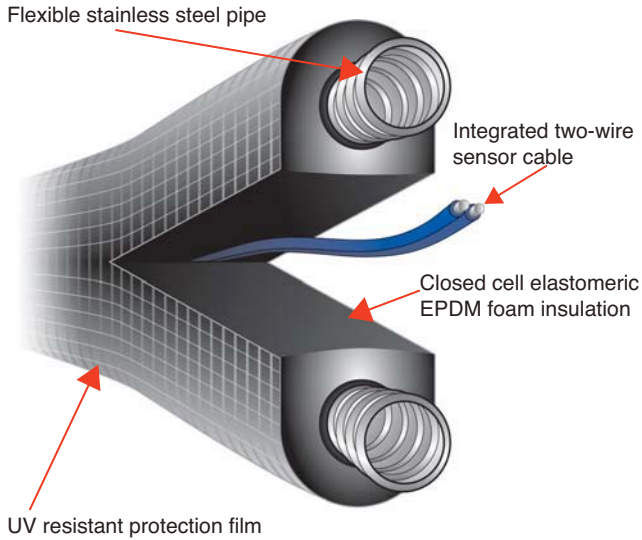

SolarFlex is packaged in a 50' coil with four 1" union nuts, four flat sealing washers, four segment rings and two each 1" male nipples. Optional pipe hangers keep pipe secure and reduce installation time.



Flow and return pipes are easy to separate without damaging the insulation or sensor cable.



Installation of union nuts



Cut pipe with tubing cutter. Do not use a hack saw.



Slide on 1" union nut and close segment ring around pipe groove.

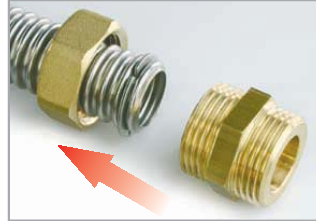

Connect 1" nipple with 1" union nut without flat-sealing washer.

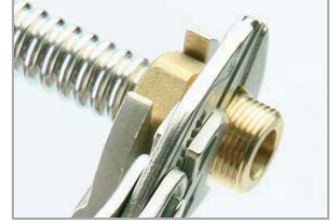

Tighten 1" nipple to 1" union nut. Forming a flat-sealing surface.

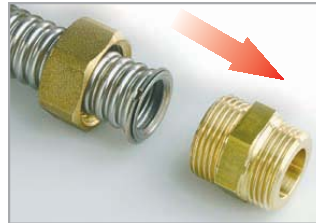

Remove union nipple to inspect flat-sealing surface.



Insert flat-sealing washer and connect to other fittings.

Using cut sections of pipe

Cut the length of pipe required to connect solar collector to the solar pumping stations and attach 1" union nut fittings on each end. Any remaining short sections of pipe can be used for tank connection or other connections.

Use connection kit **NA1210-3**, which includes four each 1" union nuts, segments rings and sealing washers.



Fitting for connecting to collectors and tanks

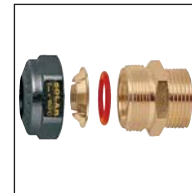

Model	Description
NA637204	1" union male to 1" union male nipple
NA10060	1" union male to 3/4" NPT female adaptor
NA10061	1" union male to 3/4" sweat adaptor
NA10062	1" union male to 1" sweat adaptor
NA10064	1" union male to 1" NPT male nipple
254462	1" union male to 22 mm compression
255862	1" union male to 22 mm compression elbow